

SAAB

90

**SERVICE
MANUAL**

1:2 Service

M 1985-

www.saab-90.nl

1985 Saab service programme

The service programme for the Saab 90 consists of one full service every 20 000 km or at least once a year and one safety and functional service every 10 000 km. A supplementary programme for every full service is also available, in order to satisfy various customer and market requirements.

The service is divided into:

Safety and functional service:

The service should be carried out every 10 000 km (10 000, 30 000, 50 000, 70 000, etc.). This consists of work designed to prevent faults and to safeguard a continued high level of safety.

Full service

The service should be carried out every 20 000 km or at least once a year. It consists of work designed to satisfy the exhaust gas emission control regulations, in addition to the work aimed at preventing faults and safeguarding the safety of the car.

Supplementary programme

The supplementary programme can be carried out either by the customer himself or by the workshop, whichever the customer prefers.

On certain markets, the work may be included as a mandatory part of the full service.

Service booklet

A service booklet is delivered with every car. This booklet must be filled in on every service occasion.

Lifting points for the Saab 90

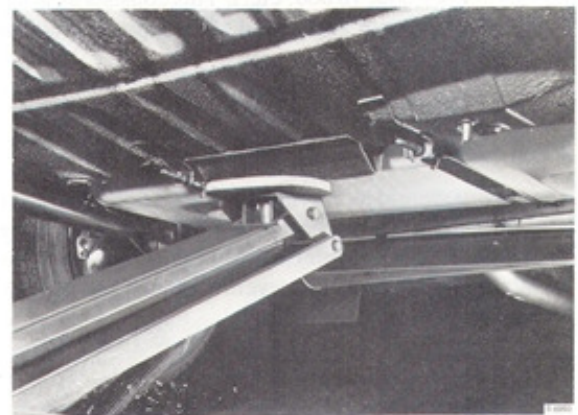
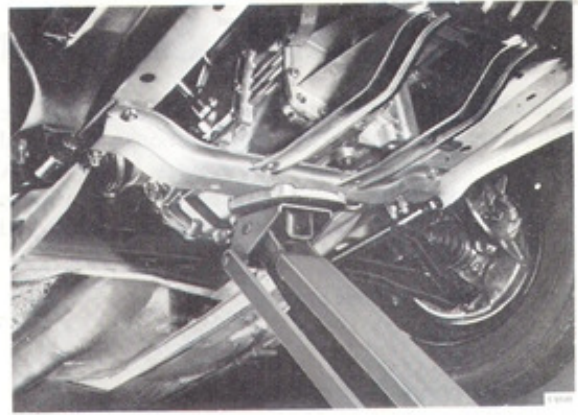

Specifications

Engine

Valve clearances, mm, with the engine cold, 30 minutes after it has been warmed up to normal running temperature.

On	checking	inlet	0.15-0.30
		exhaust	0.35-0.50
adjustment	inlet	0.20-0.25	
	exhaust	0.40-0.45	

CO on idling

Sweden, Switzerland: The hoses for the vacuum controller, crankcase ventilation and EGR must be disconnected for the CO check. In addition, the extra CO screw must be screwed in as far as it will go before adjustment.

Engine	Market	CO%	Engine speed	CO on idling	Idling speed \pm 50 r/min
CM, CA	Sweden	1.5-2.0	2000	max 4.5%	850
	Switzerland	1.4-2.0	2000	0.4-1.6*	850
	Europe	0.5-2.5	850	-	850

* Adjust as necessary by means of the extra CO screw.

Fast idling

CM, CA 1350 \pm 50 r/min

Carburettor oil type

ATF oil

Lubricating system

Oil capacity, including oil cleaner

3.8 liters

Grade of oil

To API Service SF/CC

Viscosity:

SAE 10 W 30 or 10 W 40 or 5 W 30.

On markets where these are not available, 15 W 40 or 15 W 50 may be used.

Cooling system

Collant type
volume

Saab Original Radiator Fluid
10 liters

Electrical system

Ignition system

Ignition setting before TDC at 2000 r/min with the vacuum controller disconnected

Sweden, Switzerland	18°
Europe	20°

Spark plugs

NKG BP6 ES
Champion N9YC
Bosch W7DC

Electrode gap: 0.6 mm

Power transmission

Gearbox

Oil capacity,	4-speed	approx. 2.5 liters
	5-speed	approx. 3.0 liters

Grade of oil SAE 10 W 30 or 10 W 40 engine oil or EP 75 I GL4 (GL5)

Brakes

Friction lining thickness,	new	8.8 mm
	min.	1 mm

Hydraulic fluid: To DOT4

Front assembly, Steering

Wheel alignment

All dimensions are with the car unladen

Caster	Camber	Toe-in
+1° ± 0.5°	+0.5° ± 0.5°	B-A = 2 ± 1 mm

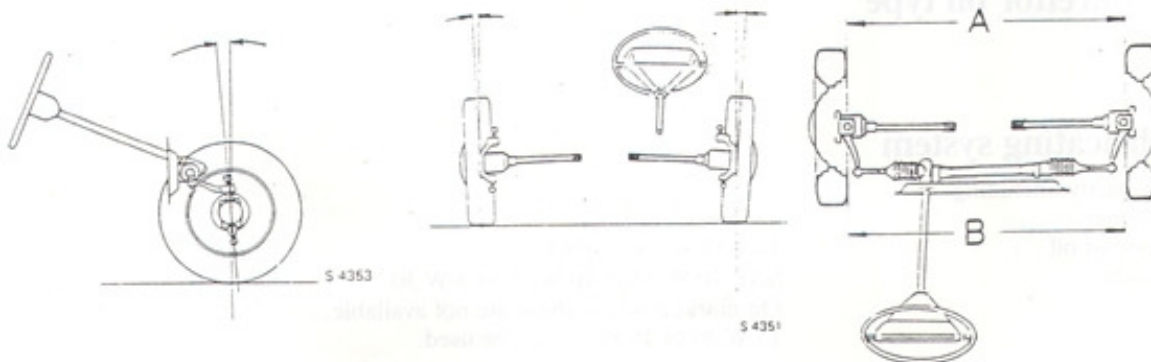

Ball joints

Max. play with no load on the joint,	axial	2 mm
	radial	1 mm

Safety and functional service

to be carried out every 10 000 km (10 000, 30 000, 50 000, 70 000 km, etc.)

Engine

1. Cooling system – check

Carry out visual inspection for tightness and coolant level. If much coolant has been lost, investigate the reason.

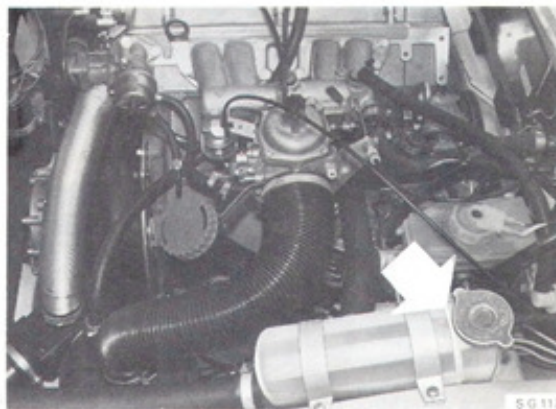

2. Fuel lines in the engine compartment – check

3. Spark plugs – check/adjust

Change, if necessary.

Electrode gap: 0.6 mm



4. Brake pads – check

Min. friction lining thickness: 1 mm

N.B. The semi-metallic friction lining at the front has a thickness of 8.8 mm when new.

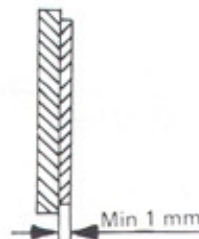

5a. Brake fluid – check the level

If the level has dropped appreciably, investigate the reason.

Grade: DOT4

5b. Brake fluid – change

Change every 50 000 km or every other year.

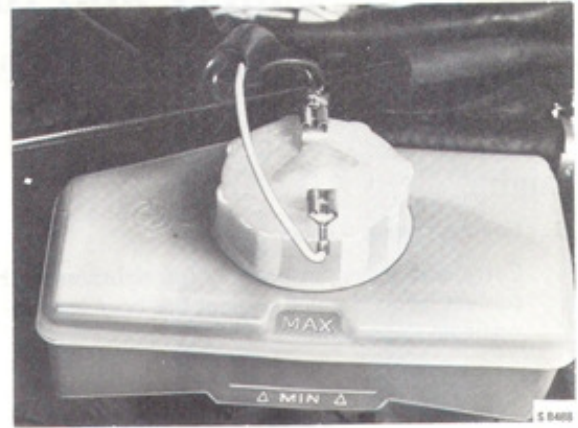
**6. Valve clearances – check/adjust**

Every 50 000 km

Remove the valve cover.

Use feeler gauges to check the maximum and minimum valve clearances.

Valve clearance on checking:	inlet	0.15–0.30
	exhaust	0.35–0.50

Adjust, if necessary

Valve clearance on adjustment:	inlet	0.20–0.25
	exhaust	0.40–0.45

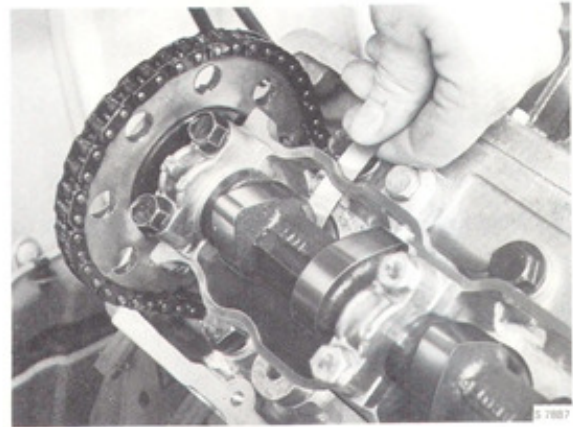
**7. Tyres – check**

Check the depth of tread and the pattern of wear.

**8. Test on the road**

Test the car on the road and check its general performance, such as engine, clutch, gearbox, brakes, wheel balance, instruments and controls. Check that there are no abnormal sounds.

Full service

to be carried out every 20 000 km, although at least once a year.

Engine

1. Engine oil filter – change

Oil the rubber gasket of the filter with clean oil before fitting the filter.



S G 090

2. Air cleaner – clean/replace

Blow the air cleaner element clean every 20 000 km and change it every 40 000 km.



14/2

3a. Exhaust gas recirculation (EGR) – check

Check the performance by observing the valve spindle movements through the ventilation holes.

The valve should be open at part throttle (2000 r/min) and an engine temp. above +45 °C

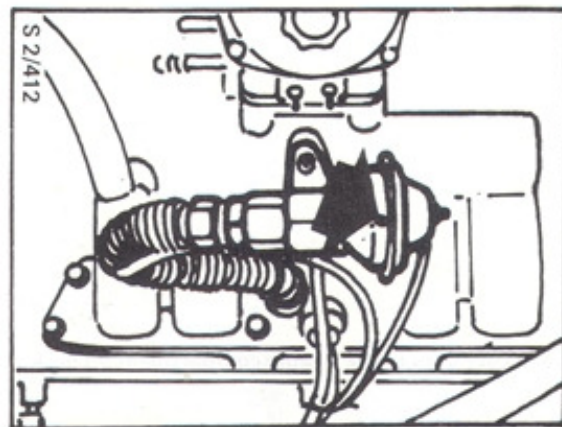

S 2/412

3b. Exhaust gas recirculation (EGR) – clean

Every 40 000 km

Remove the valve and pipe. Clean the valve using a rotating steel brush. Blow the pipe clean.

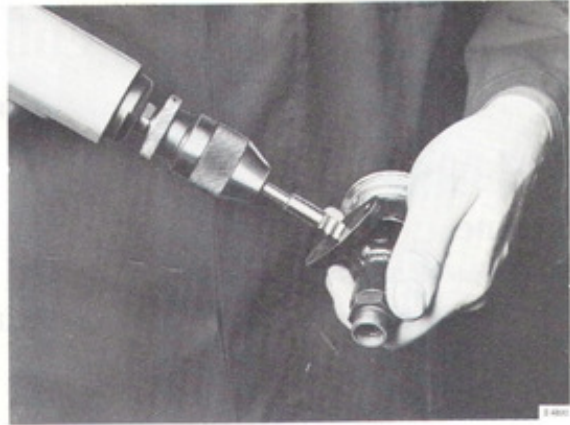
**4. Cooling system – pressure test**

Check the coolant level. If necessary, top up with a mixture of 50 % Saab Original Anti-freeze and 50 % water.

Pressure test the system with a maximum pressure of 1.2 bar (kgf/cm²).

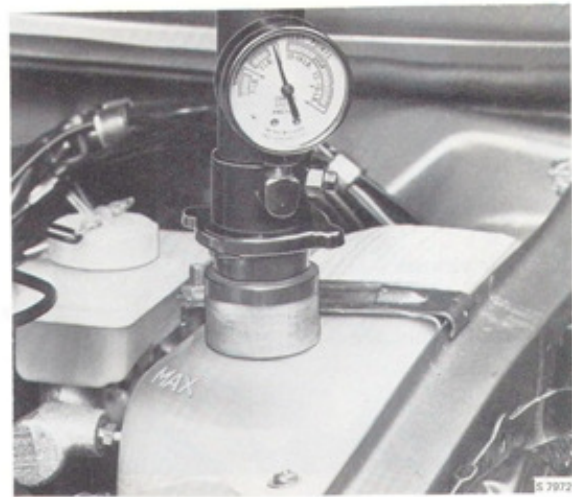
**5. Vacuum lines – check**

Check the hoses and connections for tightness.

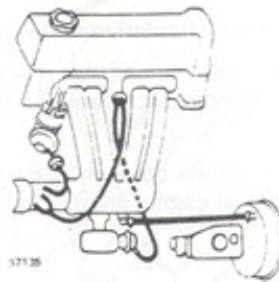
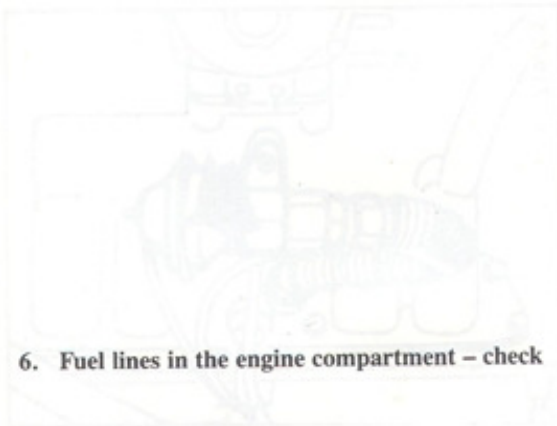
**6. Fuel lines in the engine compartment – check**

7. Choke – check

Place an 8 mm drill between the recess in the cam and the choke housing. Check that the idling speed is 1350 ± 50 r/min.

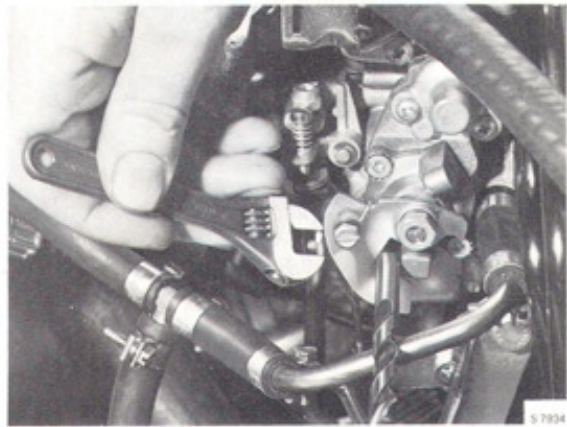
**8. Carburettor – check the oil level**

The level should be 10 mm below the filler tube opening.

Grade of oil: ATF oil

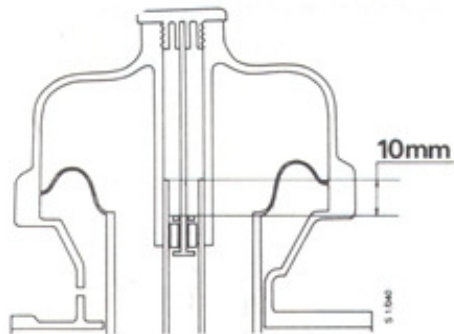
**9. CO on idling – check/adjust**

Engine warm

Sweden, Switzerland

Disconnect the crankcase ventilation and the EGR. Plug the hose to the ignition distributor.

Check the CO at 2000 r/min

The correct value is: Sweden 1.5–2.0 %
Switzerland 1.4–2.0 %

Check the CO when the engine is running at idling speed, with the hoses connected.

CO value: Sweden 4.5 % max.
Switzerland 0.4–1.6 %

If necessary, adjust by means of the extra CO screw.

Europe

Check the CO value with the engine running at idling speed (850 r/min)

The correct value is 0.5–2.5 %

Adjust the idling speed to 850 ± 50 r/min

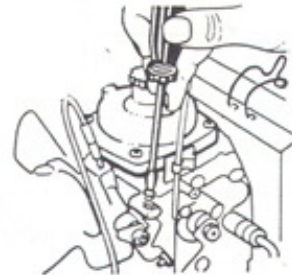

10. Exhaust system – check

Check the mountings and the pipe joints.

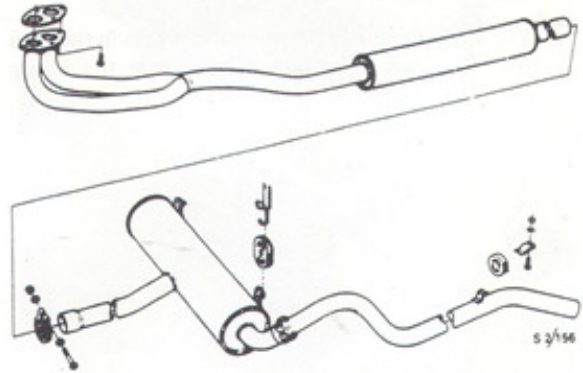
**11. Crankcase ventilation – check**

Check the hoses and connections.

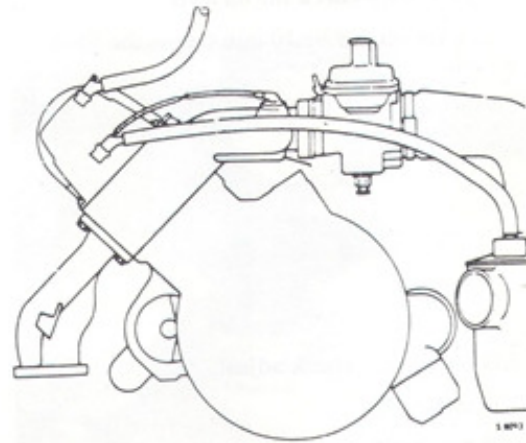
**Electrical system****12. Belt drive – check**

Check the condition and the tension of the belts.

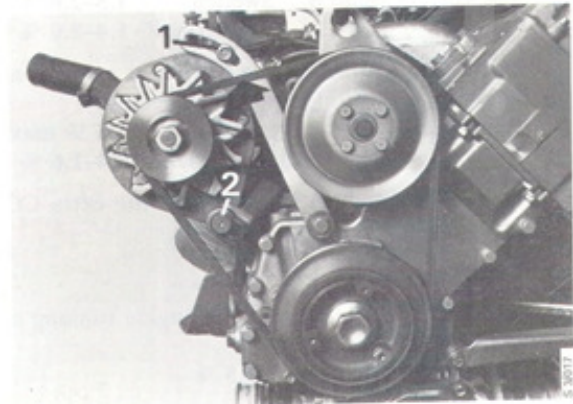
**13. Spark plugs – check/change**

Spark plugs: NGK BP 6 ES
Champion N9YC
Bosch W7DC

Electrode gap: 0.6 mm



14. Ignition leads, distributor cover – check

Inspect visually the distributor cover and ignition leads. Clean, if necessary.

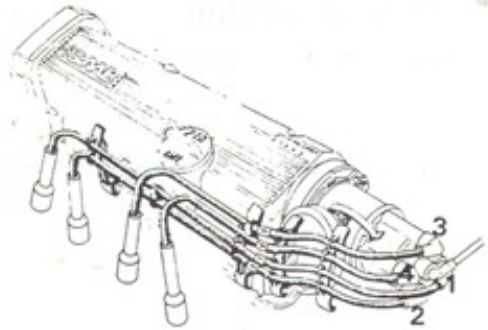

S 1/004

15. Ignition setting – check/adjust

Disconnect and plug the hose to the ignition distributor.

Check the ignition setting at 2000 r/min.

Ignition setting: Sweden, Switzerland 18°
Europe 20°

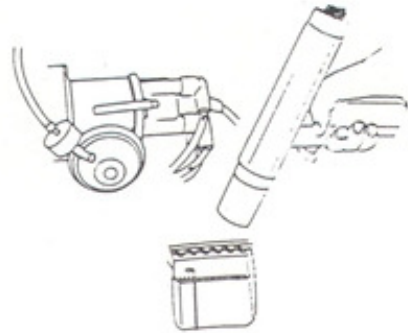
**16a. Delay valve – check**

Check that the vacuum control is delayed when the accelerator pedal is operated quickly.

Delay time: 2 seconds.

16b. Delay valve – change

Every 40 000 km.

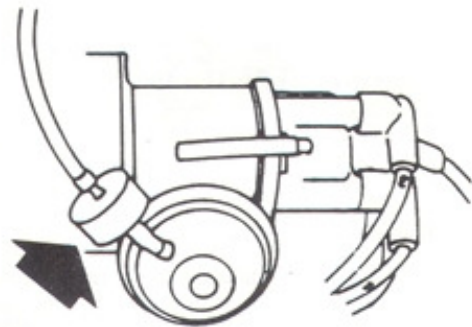
**17. Headlamps – check**

Check the headlamp setting and adjust, if necessary.

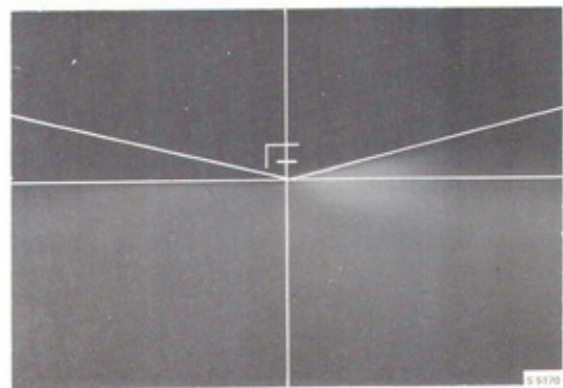

S 1/010

Power transmission

18. Gearbox oil level – check

Grade of oil:

Saab Transmisson Oil or SAE 10 W 30 or 10 W 40 engine oil or EP 75 API GL4 or API GL5.

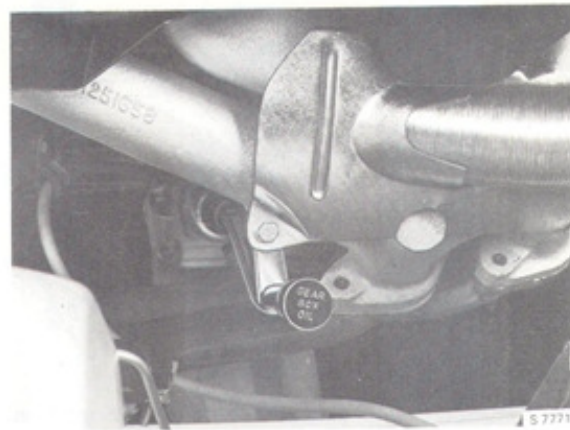

19. Brake fluid level – check

If the level is very low, investigate the reason.

Grade: DOT4.

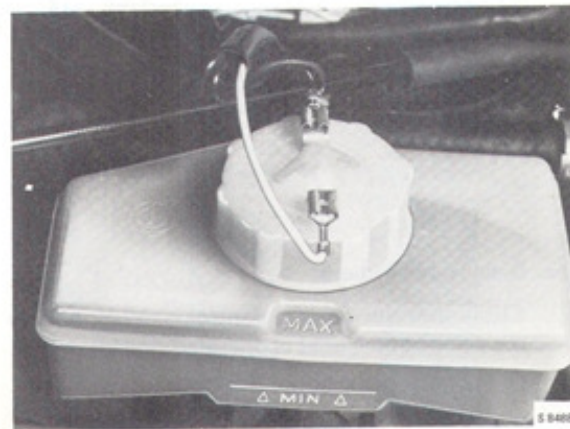

20. Brake pads – check

The minimum thickness of the friction linings is 1 mm.

N.B.

The semi-metallic lining at the front has a thickness of 8.8 mm when new.

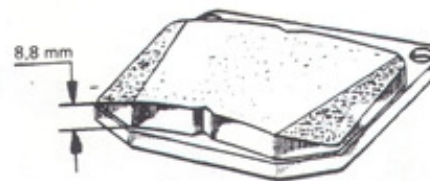

S 1/052

21. Brake lines – check

Check the hoses and lines for tightness and possible damage.

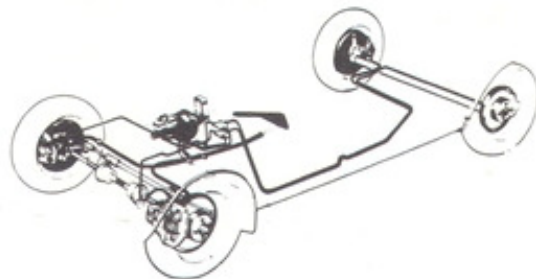
**Front assembly, steering****22. Rubber bellows – check**

Check the rubber bellows for:

- the universal joints
- the upper and lower ball joints
- the outer steering joints
- the steering gear

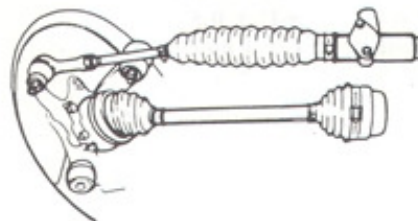
**23. Steering joints – check**

Check the outer and inner steering joints for play.

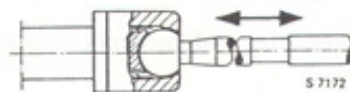
**24. Ball joints – check**

Max. permissible play: axial 2 mm
radial 1 mm

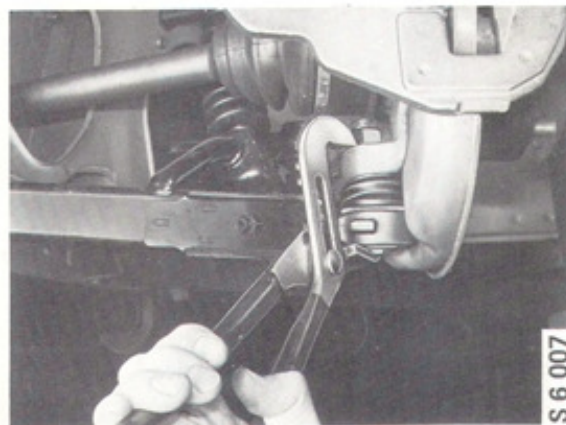

S 6 007

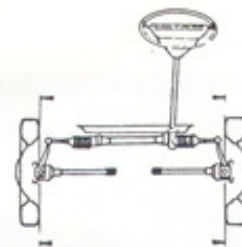
25a. Toe-in – check/adjustToe-in: 2 ± 1 mm**25b. Front wheel alignment check/adjust**

Every 40 000 km

Check all wheel angles

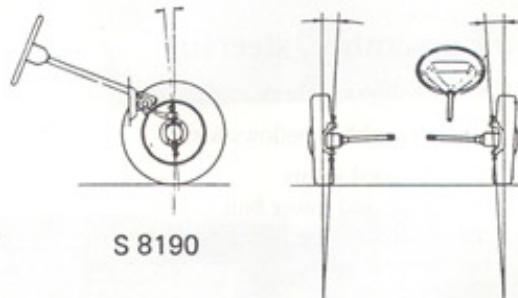
Camber $+0.5^\circ \pm 0.5^\circ$ Caster $+1^\circ \pm 0.5^\circ$ Toe-in 2 ± 1 mm**Miscellaneous****26. Tyres check**

Check for wear and the depth of tread.

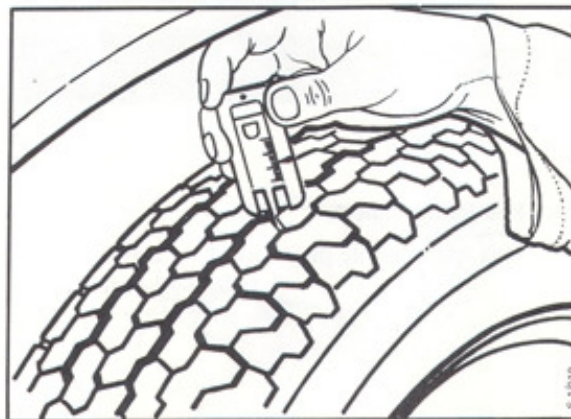
**Test on the road**

See under safety and functional service.

Supplementary programme

On certain markets, this may be included as part of the mandatory full service.

1. Functional check of the lights, horn, windscreen and headlamp washers and wipers, ventilation fan, instrument lighting, indicating and warning lamps, courtesy lights, electrically heated rear window and heater controls.
2. Coolant – check the freezing point.
3. Battery – check the electrolyte level and grease the terminals.
4. Lubricate the door stop, hinges, and bonnet locking mechanism.
5. Tyre pressures – check (also the spare wheel).
6. Washer nozzles – adjust.
7. Wiper blades – check.
8. Shock absorbers – check.

Lubrication, lubricants

Lubrication in connection with service inspection

Ref.	Lubrication point	Oty.	Lubricant	Instructions
1	Brake system	1	Brake fluid, grade DOT 4.	Change the brake fluid every 30 000 miles (50 000 km) or at 2-year intervals, whichever comes first.
	Front wheel brake caliper	2	Gleitmo 540	Lubricate the sliding surfaces between caliper and brake housing.
2	Hydraulic clutch operation		Brake fluid, grade DOT4.	
3	Engine	1	To API service SF/CC. Viscosity: SAE 10 W 30, 10 W 40 or 5 W 30	Change the oil and the oil filter cartridge every 12 000 miles (20 000 km) Note: Use only genuine Saab filter cartridges.
4	Manual transmission		SAE 10 W 30 or 10 W 40 engine oil or EP75 GL4 (GL5)	Change the oil during the warranty service. Then check the level every 20 000 km
5	Carburettor (oil damper)	1	Automatic transmission oil, type Ford M2C.33G	Check in connection with inspection.
6	Throttle control, pulley bearing	1	SAE 40 oil.	Oilcan (do not oil the throttle cable).
	Hood lock mechanism	1	SAE 40 oil.	Oilcan.
	Door hinges and door stops	4+4	SAE 40 oil.	Oilcan.

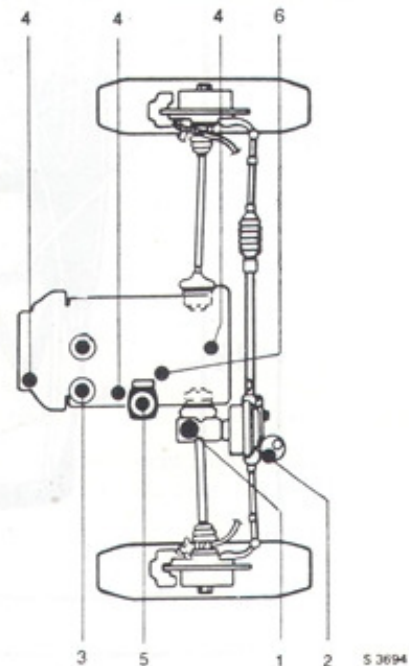
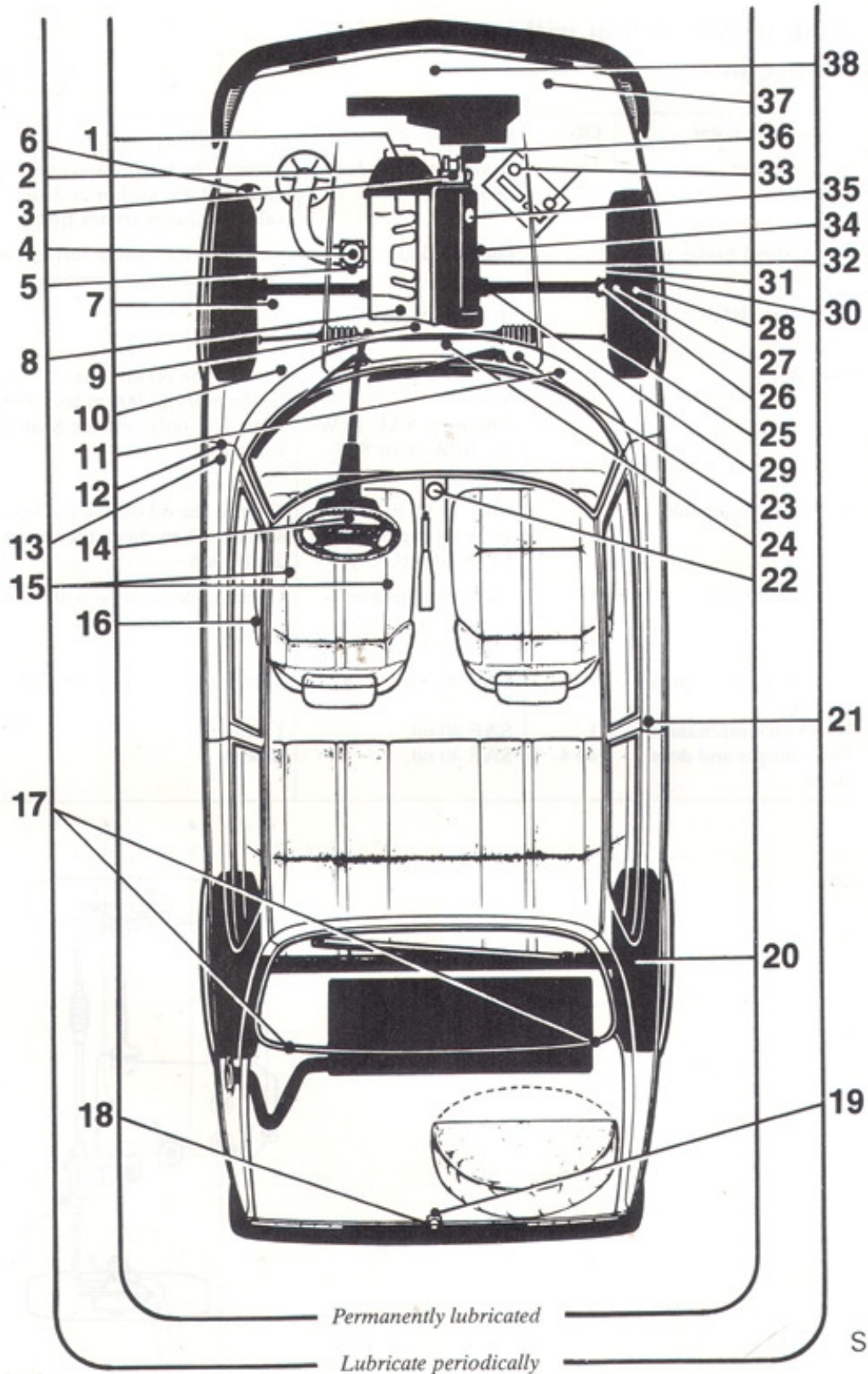

Table of lubricants



	Lubrication point	Lubricant
1	Clutch Release bearing Disc shaft splines Thrust bearing in flywheel	Permanently lubricated, do not wash Molybdenum paste part No. (45) 30 06 632 Permanently lubricated, do not wash
2	Carburettor, oil damper	ATF oil
3	Throttle control	Engine oil (Note! Do not lubricate throttle cable)
4	Handbrake cables	Chassis grease EP 2
5	Alternator ball bearings	Bosch grease Ft 1 v 34
6	Brake light contacts	Battery pole grease (Vaseline) part No. (45) 30 06 665
7	Windshield wiper motor	Permanently lubricated (special grease)
8	Door contact, interior lighting	Battery pole grease (Vaseline) part No. (45) 30 06 665
9	Door hinges	Engine oil
10	Horn slip ring and connection brush	Battery pole grease (Vaseline) part No. (45) 30 06 665
11	Seat rails	Chassis grease (sparingly)
12	Reclining seat fittings	Permanently lubricated, lubricate if necessary with thin penetrating oil
13	Hinges, luggage compartment	Chassis grease (on assembly)
14	Door contact, luggage compartment lighting	Battery pole grease (Vaseline) part No. (45) 30 06 665
15	Luggage compartment lock mechanism	Thin penetrating oil
16	Door lock mechanism	Mobilplex 47, part No. (45) 30 06 624 or Saab Special Chassis Grease
17	Gear selector housing	Soft EP1 grease
18	Engine, ventilation fan	Permanently lubricated, (Special grease)
19	Steering gear, manual (rack, pinion and bearings)	BP Energrease FGL part No. and bearings)(45) 30 08 703
20	Outer drive shaft joint	Esso Nebula EP2, Molykote VN2461c Optimol Olistamoly 2LN 584 or K.S. Paul-G800.
21	Front wheel bearings Front wheel bearings, bearing seat Front wheel bearings, hub splines	Permanently lubricated (Saab Special Chassis Grease, Esso Nebula EP2) Molybdenum paste, part No. (45) 30 06 632 Molybdenum paste, part No. (45) 30 06 632
22	Inner driveshaft joint	Esso beacon EP2 equivalent "lithium- lead Grease" which withstands severe temperature and load variations

	Lubrication point	Lubricant
23	Brake yoke slide bearing	Gleitmo 540, part No. (45) 30 08 612
24	Cam housing, handbrake adjusting mechanism	Girling Special Grease, part No. (45) 30 07 770 or disposable package, part No. 89 94 782
25	Manual transmission	SAE 10 W 30 or 10 W 40 engine oil as per API service SE or SF or to Ford specification ESE-M2C-101C or EP transmission oil SAE 75 as per API-GL4
26	Battery	Battery pole Grease (Vaseline)
27	Starter motor, bushes thrust bearings, links springs	Bosch oil 01 v 13 Bosch Grease Ft 2 v 3
28	Engine	SAE 10 W 30, 10 W 40 or 5 W 30 engine oil as per API service SE or SF or to Ford specification ESE-M2C-101C (do not use any "additive")
29	Cooling fan	Permanently lubricated (Special Grease)
30	Headlamp wiper motors	Permanently lubricated (Special Grease) Calypsol H 529
31	Hood lock, hinges Locking pin, hood	Engine oil Chassis Grease

Lubrication to prevent seizing

Screw connections which are subjected to large temperature variations may tend to seize and render dismantling difficult at the next scheduled service.

Screw connections of this type are:
EGR valve connections

Recommended lubricants:
NEVER SEIZE or MOLYCOTE 1000

Saab-Scania AB
Saab Car Division
Nyköping, Sweden

GB English edition. Ordering No 327502. Printed in Sweden by Graphic Systems AB, Göteborg 1984.



www.saab-90.nl